

LMK 382



Stainless Steel Probe

Ceramic Sensor

accuracy according to IEC 60770:
standard: 0.35 % FSO
option: 0.25 % FSO

Nominal pressure

from 0 ... 40 cmH₂O up to 0 ... 200 mH₂O

Output signals

2-wire: 4 ... 20 mA
3-wire: 0 ... 10 V
others on request

Special characteristics

- ▶ diameter 39.5 mm
- ▶ especially for sewage, viscous and pasty media

Optional versions

- ▶ IS-protection zone 0
- ▶ mounting with stainless steel pipe
- ▶ flange version
- ▶ diaphragm 99.9 % Al₂O₃
- ▶ different kinds of cables
- ▶ different kinds of elastomers

The stainless steel probe LMK 382 has been designed for continuous level measurement in waste water, waste and higher viscosity media.

Basic element is a robust and high overpressure capable capacitive ceramic sensor e.g. for low levels easily.

Preferred areas of use are



Water

drinking water abstraction



Sewage

waste water treatment
water recycling



Fuel / Oil

level monitoring in open tanks
with low filling heights
fuel storage
tank farms / biogas plants



Input pressure range																
Nominal pressure gauge	[bar]	0.04	0.06	0.1	0.16	0.25	0.4	0.6	1	1.6	2.5	4	6	10	16	20
Level	[mH ₂ O]	0.4	0.6	1	1.6	2.5	4	6	10	16	25	40	60	100	160	200
Overpressure	[bar]	2	2	4	4	6	6	8	8	15	25	25	35	35	45	45
Output signal / Supply																
Standard		2-wire: 4 ... 20 mA / V _S = 9 ... 32 V _{DC}														
Option IS-protection		2-wire: 4 ... 20 mA / V _S = 14 ... 28 V _{DC}														
Option 3-wire		3-wire: 0 ... 10 V / V _S = 12.5 ... 32 V _{DC}														
Performance																
Accuracy ¹		standard: ≤ ± 0.35 % FSO option: ≤ ± 0.25 % FSO														
Permissible load		$R_{max} = [(V_S - V_{Smin}) / 0.02 A] \Omega$														
Influence effects		supply: 0.05 % FSO / 10 V load: 0.05 % FSO / k Ω														
Long term stability		≤ ± 0.1 % FSO / year at reference conditions														
Turn-on time		700 msec														
Mean response time		< 200 msec										measuring rate 5/sec				
Max. response time		380 msec														
¹ accuracy according to IEC 60770 – limit point adjustment (non-linearity, hysteresis, repeatability)																
Thermal effects (Offset and Span)																
Thermal error		≤ ± 0.1 % FSO / 10 K in compensated range 0 ... 70 °C														
Permissible temperatures																
Permissible temperatures		medium: -25 ... 125 °C electronics / environment: -25 ... 125 °C storage: -25 ... 125 °C														
Electrical protection ²																
Short-circuit protection		permanent														
Reverse polarity protection		no damage, but also no function														
Electromagnetic compatibility		emission and immunity according to EN 61326														
² additional external overvoltage protection unit in terminal box KL 1 or KL 2 with atmospheric pressure reference available on request																
Electrical connection (only for 4 ... 20 mA / 2-wire)																
Cable with sheath material ³		PVC (-5 ... 70 °C) grey PUR (-25 ... 70 °C) black FEP ⁴ (-25 ... 70 °C) black TPE (-25 ... 125 °C) blue														
³ shielded cable with integrated air tube for atmospheric pressure reference																
⁴ do not use freely suspended probes with an FEP cable if effects due to highly charging processes are expected																
Materials (media wetted)																
Housing		stainless steel 1.4404 (316 L)														
Seals		FKM FFKM EPDM others on request														
Diaphragm		standard: ceramics Al ₂ O ₃ 96 % Option: ceramics Al ₂ O ₃ 99.9 %														
Nose cone		POM														
Explosion protection																
Approval DX14-LMK 382		IBExU05ATEX1070 X zone 0 ⁵ : II 1G Ex ia IIB T4 Ga zone 20: II 1D Ex ia IIIC T85 °C Da														
Safety technical maximum values		U _i = 28 V, I _i = 93 mA, P _i = 660 mW, C _i = 27 nF, L _i = 5 μ H														
Permissible media temperature		in zone 0: -10 ... 60 °C with p _{atm} 0.8 bar up to 1.1 bar zone 1 and higher: -10 ... 70 °C														
Connecting cables (by factory)		cable capacitance: signal line/shield also signal line/signal line: 160 pF/m cable inductance: signal line/shield also signal line/signal line: 1 μ H/m														
⁵ for optional stainless steel pipe following designation is valid: "II 1G Ex ia IIC T4 Ga" (zone 0)																
Miscellaneous																
Current consumption		max. 21 mA														
Weight		approx. 400 g (without cable)														
Ingress protection		IP 68														
CE-conformity		EMC Directive: 2004/108/EC														

Wiring diagram

2-wire-system (current)

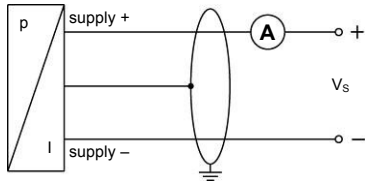

3-wire-system (voltage)

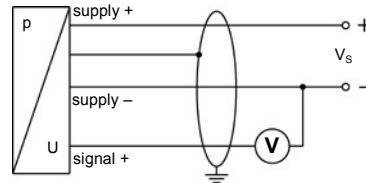

Pin configuration

Electrical connection	cable colours (DIN 47100)
Supply +	wh (white)
Supply -	bn (brown)
Signal + (only for 3-wire)	gn (green)
Shield	gn/ye (green / yellow)

Dimensions (in mm)

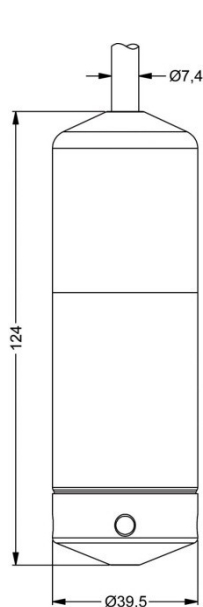

LMK 382 standard

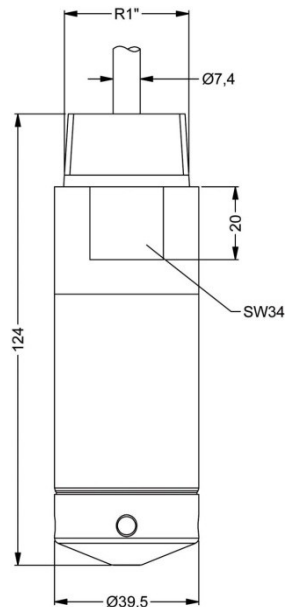

LMK 382 with thread R1"
for stainless steel pipe

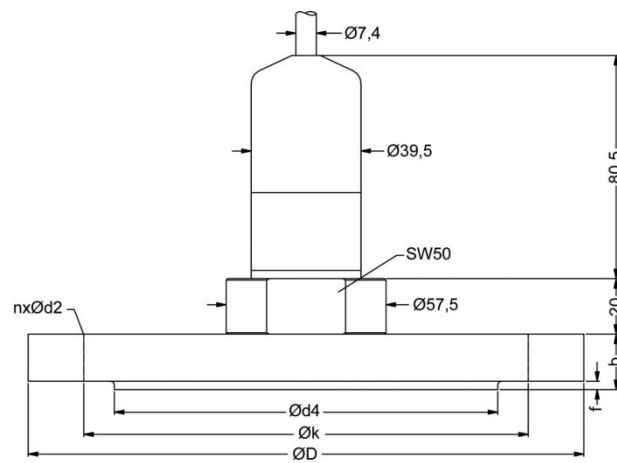

LMK 382
flange version

dimen- sions	dimensions in mm			
	DN25 / PN40	DN40/ PN40	DN50 / PN40	DN80 / PN16
D	115	150	165	200
k	85	110	125	160
d4	68	88	102	138
b	18	18	20	20
f	2	3	3	3
n	4	4	4	8
d2	14	18	18	18

Transmitter flange for flange version		
Technical data		
Suitable for	LMK 382, LMK 382H, LMK 458, LMK 458H	
Flange material	stainless steel 1.4404 (316L)	
Hole pattern	according to DIN 2507	
Version	Size (in mm)	Weight
DN25 / PN40	D = 115, k = 85, b = 18, n = 4, d = 14	1.2 kg
DN50 / PN40	D = 165, k = 125, b = 20, n = 4, d = 18	2.6 kg
DN80 / PN16	D = 200, k = 160, b = 20, n = 8, d = 18	4.1 kg
Ordering type		Ordering code
Transmitter flange DN25 / PN40		ZFS2540
Transmitter flange DN50 / PN40		ZFS5040
Transmitter flange DN80 / PN16		ZFS8016

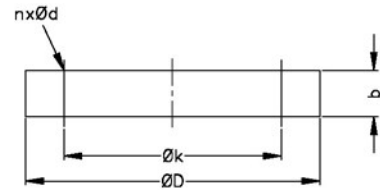

Mounting flange with cable gland		
Technical data		
Suitable for	all probes	
Flange material	stainless steel 1.4404 (316L)	
Material of cable gland	standard: brass, nickel plated on request: stainless steel 1.4305 (303); plastic	
Seal insert	material: TPE (ingress protection IP 68)	
Hole pattern	according to DIN 2507	
Version	Size (in mm)	Weight
DN25 / PN40	D = 115, k = 85, b = 18, n = 4, d = 14	1.4 kg
DN50 / PN40	D = 165, k = 125, b = 20, n = 4, d = 18	3.2 kg
DN80 / PN16	D = 200, k = 160, b = 20, n = 8, d = 18	4.8 kg
Ordering type		Ordering code
DN25 / PN40 with cable gland brass, nickel plated		ZMF2540
DN50 / PN40 with cable gland brass, nickel plated		ZMF5040
DN80 / PN16 with cable gland brass, nickel plated		ZMF8016

cable gland M16x1.5 with seal insert (for cable-Ø 4 ... 11 mm)

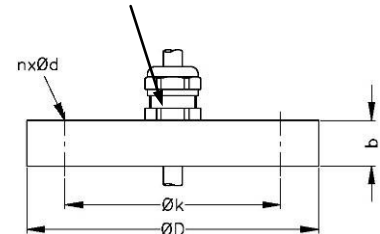

Terminal clamp		
Technical Data		
Suitable for	all probes with cable □ 5.5 ... 10.5 mm	
Material	standard: steel, zinc plated optionally: stainless steel 1.4301 (304)	
Weight	approx. 160 g	
Ordering type		Ordering code
Terminal clamp, steel, zinc plated		Z100528
Terminal clamp, stainless steel 1.4301 (304)		Z100527

